

Warranty

► For after-Sale service, have the following ready when you contact our branches.

1. Name of the product.
2. Model number of the product.
3. The area of problem.
4. Phone number and address at which you can be contacted.

Warranty Card

PRODUCT	
MODEL	
DATE PURCHASED	
WARRANTY PERIOD	
AGENCY ADDRESS	

► KOCOM Warranties the original purchaser of this product as follows.

- 1) This product is produced under strict quality control and inspection procedures.
- 2) If this product breaks down during proper use as a result of product defect, KOCOM will repair it within one year from date of purchase free of charge.
- 3) The following cases will be subject to charge, even during warranty period:
 - a. Breakdown during transport, or through careless treatment, by consumer.
 - b. Breakdown cause by unauthorized repair, or system modification.
 - c. Breakdown caused by natural disaster or power disorder.

KOCOM SINCE 1976
KOREA COMMUNICATIONS CO.,LTD

<http://www.kocom.com>

E-mail : export@kocom.co.kr

This manual is based on the date as shown in the right and specifications are subject to change without notice for quality improvement

KCV-301 09.10

KOCOM

KCV-301

[Operating Installation Manual]



KCV-301



KVR-300 [OPTION]

- 3.5" Digital color LCD
- Communication with door and door monitoring
- Door open during communication
- Intercom function between extended indoor units
- Surface mount type installation
- External 64 cut memory equipment (KVR-300) connection -(B/W)
- Connection with up to 2 door cameras, 2 monitors and 2 sub audio phone (KDP-602G)
- 5 melody selection



KC-MC24



KC-MC20



KC-C60



KC-MC30

KOCOM CO.,LTD.

Cautions for safety

For safe use, please stick to the following cautions.

- Please, save this manual after reading these instructions carefully.
- Read and understand all instructions to set up rightly.
- This Cautions for Safety may include items that are not contained in specifications of the product that consumer purchases.
- If you need assistance with the set-up or operation, please contact with A/S center.

The important marks in the manual.

To help our customers to understand this manual, to prevent any personal injury or property damage, some marks are used in the manual.

The marks and the drawing signs are below. Please, understand the marks before reading the manual.

The meaning of the drawing signs.

	Sign to show what not to do		Mishandling the device with ignoring this sign may result in serious injury or death.
	Mishandling the device with ignoring this sign may result physical injury or material damage.		
	Sign to tell you that you should follow the instructions.		Sign to tell you that you need more attention including high voltages, electric shock, danger, warning)
	Sign to tell you that you can't disassemble this unit.		Sign to tell you that you must unplug the unit.

Caution

Cautions for set-up

- The law limits distributing the power lines to an authorized person from government. The work from an unauthorized person cause fire or electric shock.
- Place this unit securely on a stable surface. Serious damage and/or injury may result if the unit falls.
- Do not set up this unit near the leaking place because it may expose you to dangerous voltages or other risks.
- Even if your product is water proof, do not install it slanted place of water leakage, which can a short circuit.
- The work of distributing wires needs skills and experiences. So please, for assistance, contact your dealer or call service center.
- The communication lines should be built in being distant from the power source. This may result in the risk of fire, electric shock and communication disorder.
- Setting the communication lines in a high humid place such as outside without any protection from rain causes the communication disorder.
- Keep the hook at the wall-mounted device safe. The hook may cause the physical injury.
- Think about the thickness and quality of wall material. The unqualified material may make the device fall.
- Set the device of the wall-mounted type not to fall. Falling from an earthquake causes personal injury.

Cautions for Repairs and Maintenance

- Keep the inside of the device clean. Having the dust inside without any cleaning for a long time causes the fire. If necessary, contact your dealer or service center to get cleaning service.
- Unplug this device when you want to check the inside. If there is no plug, please, turn off the circuit breaker.
- Unplug this device when you try to move it to another place. If the electric line is connected inside of the unit, please contact your dealer or service center.
- Do not use liquid or aerosol cleaners. Use a damp cloth for cleaning

Warning

Warnings for Usage

- Do not install this unit near the water and dust, for example, in a bathroom or near the washing machine. It caused fire and electric shock.
- Do not install this unit near the fire, for example, near kitchen sink, heater or the like.
- Do not install near the noxious gas such as Hydrogen Sulfide, metal power and the like.
- Do not install near the water and chemicals.
- Do not give any damage, break and modify the plug. Overloading, heating, pulling causes the damage.
- Do not place the plug near the heater. The damaged code causes fire and electric shock. Do not pull the power code when unplugging.
- The damaged code causes fire and electric shock. Must pull with plug. Do not touch with wet hands. It causes the electric shock.
- Do not use any other voltage, except the marked regular voltage.
- Do not use the power terminal at the units to other electric device except the designed device.
- Do not install the units at the leaking place if it doesn't have any waterproof mark. Do not install the unit when the power is on.
- Install the circuit breaker after checking the safety such as electric shock and leakage. Turn off the power before you install or A/S
- Check the suitability of the lines for installing when you use the exiting lines.
- Do the wiring work by using the designed material.
- Connect the electric wire with the designed ways and ground.
- Do not connect with any other devices except the designed devices to compose the system.
- Unplug electric wire and communication lines from the units before moving to another place.

Cautions for Use

- This unit is not designed for security purpose. Do not handle the unit with the wet hands.
- Do not place a pot with water or a small metal material on the Units.
- Do not cover the ventilating opening or put any metal material in the units.
- During thunderstorms, avoid using this unit. There may be a remote risk of an electric shock from lightning.
- Do not modify the unit. Open the main gate after checking ID if the image and sound system do not work. Call A/S

Cautions for Abnormality

- Change the damaged electric code.
- Unplug this unit from plug socket and refer servicing to an authorized service center when the following conditions occur:
 - If liquid has been spilled into the unit.
 - If the unit does not work normally by following the operating instructions.
 - If the unit exhibits a distinct change in performance.
 - If the unit has been dropped or physically damaged.

Caution

Safety Instructions, Warnings and Cautions of Each System

- Do not disassemble this unit at will as this device is composed by precision parts. Install the unit by following the set-up instructions of Kocom.
- Do not touch or insert any foreign substances, for example, sticker, magnetic, opener and the like
- Make U-type at the end of wires as the rain can effect on the system by following the wires during the rainy season.

Videophone

- Separate the AC/DC lines with the hook of the wall-mounted type when installing. Connect the lines after peeling the wires properly
- Do not distribute signal line with AC line. Use the designed driver to connect the lines to terminal
- Do not clean the LCD with the damp cloth for cleaning. Use the only dry and soft cloth. Do not install the main gate monitor at the leaking place.

Things You Need to Know

- This product is designed as a home videophone and cannot use continuously like monitor camera.
- If there is temperature difference between inner part of camera and surrounding, dew condensation occurs on camera lens and may disturb image. If dew condensation is removed from camera lens, image quality recovers.
- White LED light examination range is narrower than camera shot range at night, so there is less amount of light at night than day. So it is difficult to see the face in low illumination condition due to noise increase on screen, but it is not from defect.
- Monitor screen (liquid crystal panel) is not in defect when some pixels always light or black out.
- Please install monitor and camera over 5cm away. Also, avoid installing at a place with too much noise, because too much noise around camera causes phone call inferiority.
- Do not place an object within 20cm in front of monitor. It causes phone call inferiority, especially because microphone is installed at the top of monitor.
- If strong light such as sunlight flows into camera module, screen saturation (or strange mark) and image shaking might occur.
- This is not a defect, so please do not install camera where a direct ray of light do not flow if possible.

Cautions

- In some cases there is occurrence of product destruction, malfunction, noise mixing and picture quality deterioration due to mixing of other tool's induced voltage or thunder with communication wiring of monitor/camera, monitor/extended monitor.
- Do not wire with power line such as outdoor wiring or AC power, or phones and other tools.
- You cannot use it if you incorrectly wire the AC voltage between monitor/camera, monitor/extended monitor. Call the store or agency where you purchased this product and consult to solve the problem.
- Beware that unfixable damage might be caused due to authorizing AC voltage on communication wiring of monitor/camera, monitor/extended monitor.
- Do not ever disjoint this product. It may cause electrocution accident when touching high-voltage circuit inside this product.
- Outside power authorizing this product must be confirmed of product description and use rated voltage. Beware that if higher voltage is authorized, unfixable damage might be caused due to product destruction.
- Power must be connected to domestic voltage (product rated voltage) consent or interior wiring.
- If connected to other motive power or inverter-type power, product destruction, noise mixing, and picture distortion may occur.
- Do not drop this product. Glass is used for monitor and might break, or cause other circuit inferiority.
- In such case, immediately turn down the power switch, and call to consult agency or store in which this product was purchased.
- If installed near transmission antenna such as broadcasting station, electric wave may mix and cause picture distortion or voice mixing.
- Avoid installing near tools with strong electromagnetic waves such as microwaves and cell phones, or it may cause picture distortion.
- Do not install monitor in following places.
 - ① Above or around water heater, rice-cooker, heater
 - ② Place exposed to direct rays of the sun
 - ③ Place with temperature below 0°C such as cold store
 - ④ Place with high humidity such as bathroom, washroom, heated room
 - ⑤ Place with a lot of gas, dust, smoke
 - ⑥ Dangerous place with sprays of water or chemicals
- Do not wipe with insecticide, drugs or chemicals such as thinner and alcohol, or it may damage the surface of this product.
- Beware of occurrence of image quality deterioration or malfunction from cause of humidity due to penetration of chemicals or water into camera's urea resins.
- As in the picture, it prevents temperature difference of camera (outside) and monitor (inside), and removes dew condensation caused by humidity of camera window.
- Camera must be installed when wall cement is completely dry.
- When product is installed in winter below -5°C, wait for approximately 2 hours to connect. Dew formation in monitor and camera due to temperature difference inside and outside may cause product defect.
- Avoid installing monitor and camera in place directly exposed to heat or where gas noxiousness is highly occurring.

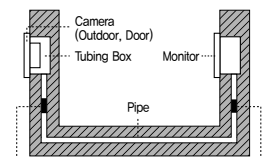

Stop up P.V.C pipe using adiabatic substances, to prevent air circulation

Monitor Installation

▶ Basic Installation method of Monitor

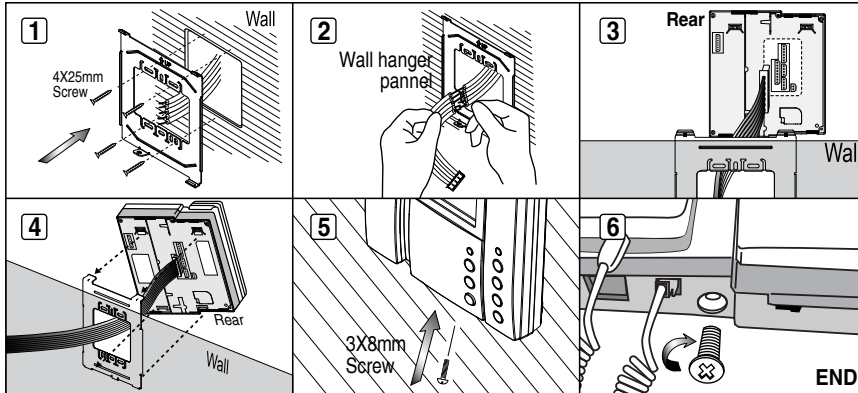

■ Standard Height of Monitor

- ▶ Standard height of monitor is 1,450~1,500mm from bottom to the center of monitor screen.
- ▶ For installation, avoid the places where there is any excessive humidity, magnetic force, dangerous chemicals, direct ray of sun, and any places near a heater which can cause break down.

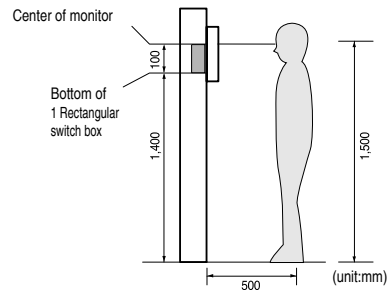

Door camera Installation

▶ Door Camera Installation

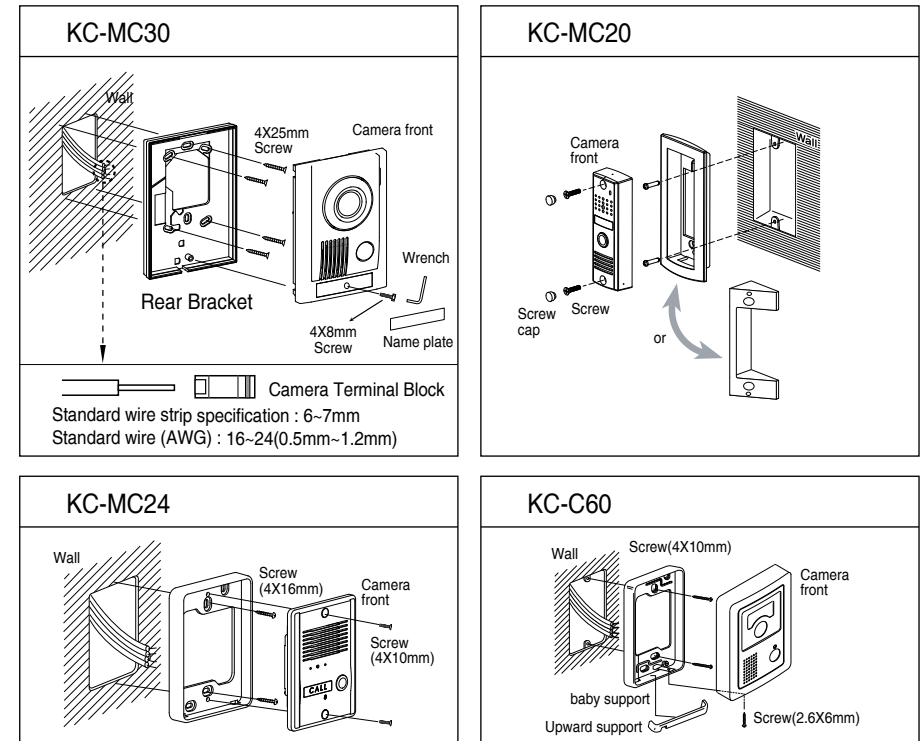

After fix the rear bracket with 4 screw, put the Door Camera into the grooves of rear bracket, and then fix it with hexagon screws and stick the finishing materials.

■ Standard Height of Door Camera

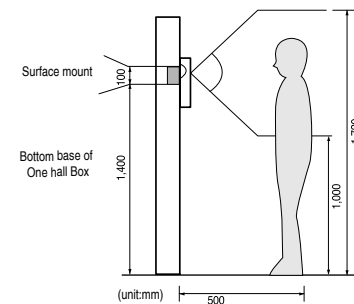

- ▶ Standard height of door camera is 1,400~1,450mm from the bottom of one camera to the floor.
- ▶ In case that the height of Door camera exceeds the range of min. 1,250mm ~ 1,550mm, it is impossible to control the screen picture with only the angle, and therefore, be careful of the height of camera in installation.

Precautions for Operation



Keep away from humidifier and stove. High temperature and humidity can cause breakdown.

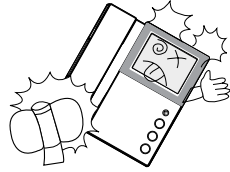

Do not drop monitor or door camera, and avoid strong impact.

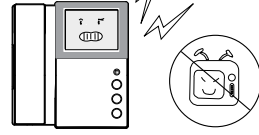

Keep away from devices generating strong magnetic field (TV, Speaker, etc.) (Picture can be disturbed or blurred and breakdown can result)



When cleaning, never use wet hands, volatile benzene or paint thinner.

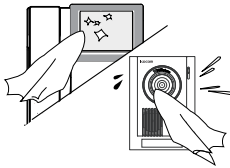

Keep picture clear by cleaning camera window frequently with soft cloths.

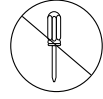

As this device consists of electronic precision components, and high voltage is generated internally, do not attempt to disassemble.

※ According to outside environment, you may view the images somewhat unclear. However, they do not result from any defect or trouble of the product.

Installation Precautions

- Monitor and camera must be installed away from direct light and counter light.
- Camera must be installed at a place free from rain.
- Standard height of monitor must be 1,450mm~1,500mm from ground and centered around monitor screen.
- Camera should be installed on the wall in which cement is completely dry.
- If installed during winter season at temperature below -5°C, condensation might be generated inside monitor and camera due to temperature difference between indoors and outdoors.
To prevent breakdown due to such condensation, connection should be made in 2 hours or more after installation.
- Do not install monitor and camera in locations subject to direct heating as harmful gases may subsequently be emitted in significant amounts.

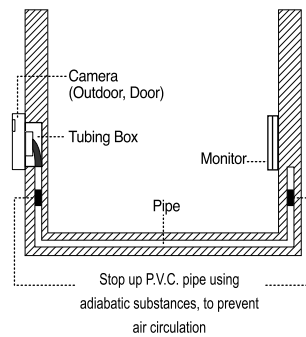

※ Stopping up pipe as above minimizes temperature difference between indoors and outdoors, and also eliminates moisture and condensation on door camera window.

Component

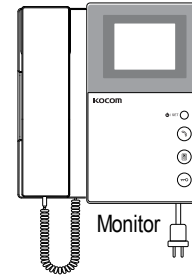

Monitor

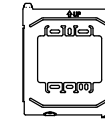

Wall hanger bracket
Wall hanger bracket is packed in the Monitor

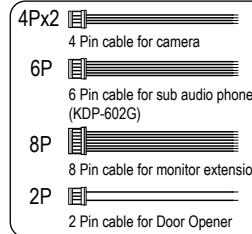

Wire

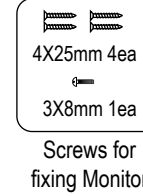

Screws for fixing Monitor

Door Camera

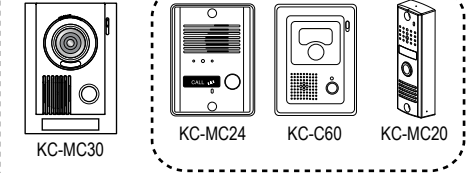

Rear Bracket

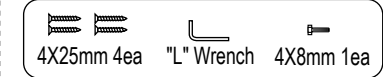
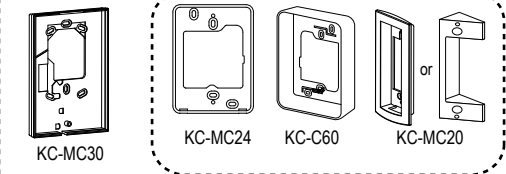

Screws for fixing Camera

Specifications

MONITOR	MODEL NO.	KCV-301		
	Power Source	SMPS AC 90-240V (50Hz/60Hz)		
	Power Consumption	Max: 20W, Standby 1.6W		
	Operating Temperature	0°C ~ +40°C		
	LCD	3.5" Digital color LCD		
	Communication System	Duplex handset conversation		
	Call Sound	Melody Sound		
	Wiring	4 Wires (camera), 6Wires (audio phone), 8Wires (video phone)		
	Mount Type	Surface mount		
	Max.Wiring Distance	TIV 0.8mm Cable=100m, UTP CAT5=100m		
Dimension	210 (W) x 222(H) x 57(D)mm			
Indoor Unit Connection	KDP-602G (Audio phone), KVM-C301			
Camera Connection	KC-MC30, KC-MC24, KC-C60			
Door Camera	MODEL NO.	KC-MC30	KC-MC24	KC-C60
	Power Source	DC12V ± 1V (power from Monitor)		
	Power Consumption	Max: 3W (In Load)		
	Operating Temperature	-10°C ~ +50°C		
	Min. Illumination	0.1Lux (LED ON)		
	Dimension	110(W)x158(H) x39(D)mm	96(W)x127(H) x32(D)mm	95(W) x 127(H) x 34(D)mm
	Angle of Lens	Diagonal 120° (angle adjustable)	Diagonal 90°	Diagonal 120°

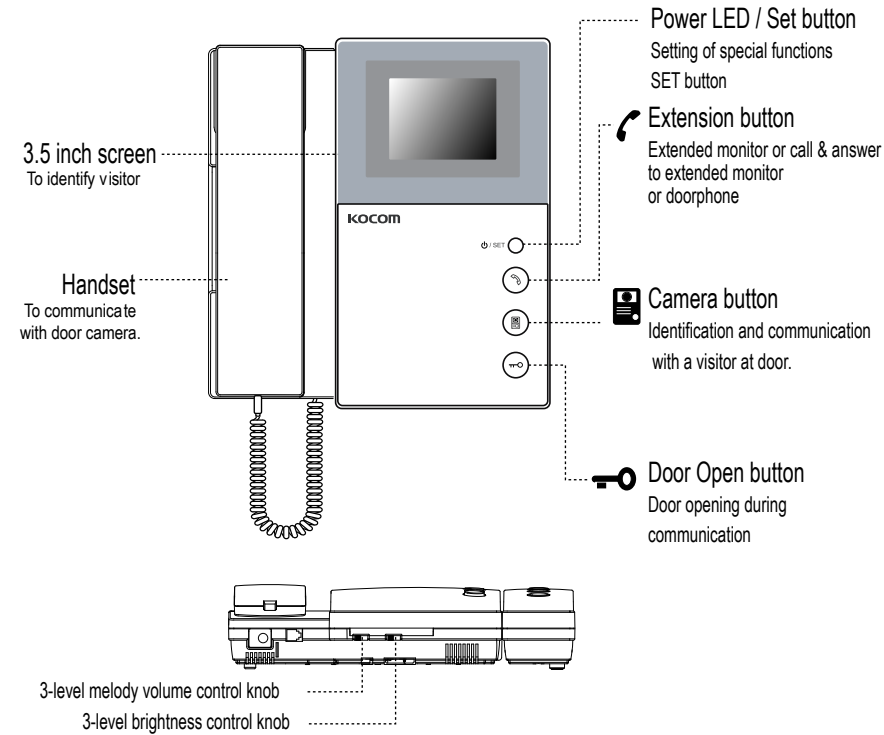

■ Door Camera

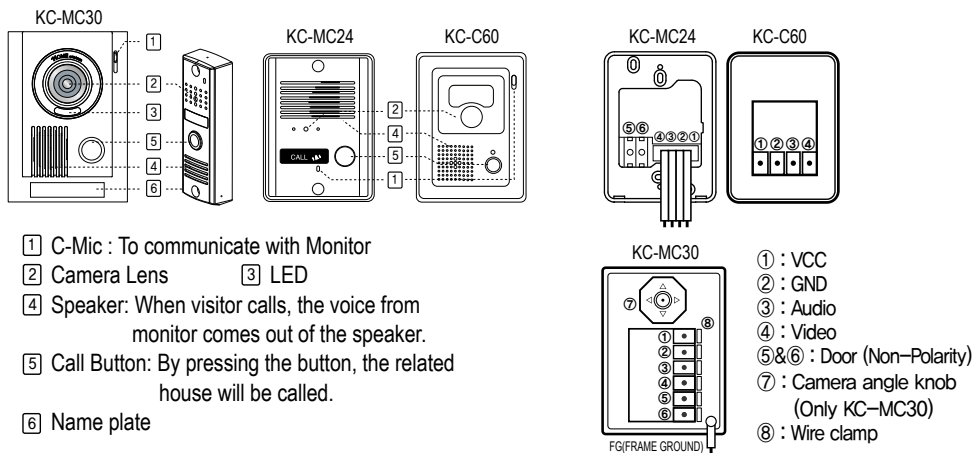

■ Communication with door camera



When visitor presses the call button of door camera, the call from the door panel keeps ringing for 2 minutes. But monitor screen will be turned on for 1 minute. Monitor button won't function during the rest 1 minute. At this time, when holding the handset, the screen will be turned on and communication will be available.

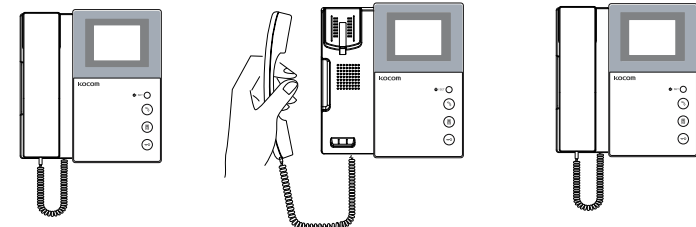

While melody sounds from the monitor, the image of a visitor at door is displayed.

Pick up the handset to communicate with a visitor at door. In case the handset is used with extended indoor units, press camera button for communication.

Hang up the handset to finish communication. Communication with door is available for up to three minutes.

■ Camera monitoring-Don't need to hold handset

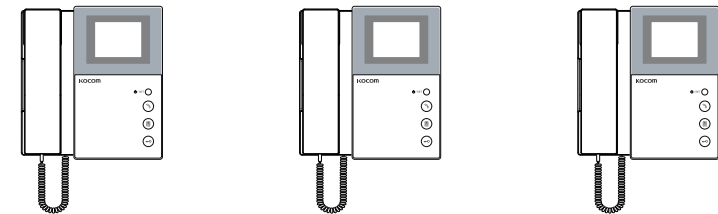

To view the state of door without communication, press camera button and view the image from door camera 1 through the screen.

To view the image from door camera 2 through the screen, press camera button once more.

To end door monitoring, press camera button once more.

Door camera monitoring is available for up to one minute.

■ Opening door automatically

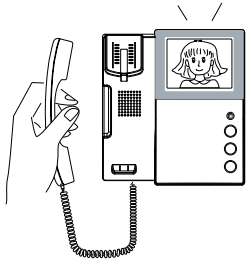

For this purpose, automatic DC doorlock should be installed on the door and connected to camera or monitor.

If you press Door open  button during the communication with door, the door is opened automatically.

After opening the door, you may end the communication by hanging up the handset or pressing camera  button.

■ Extension Call & Communication

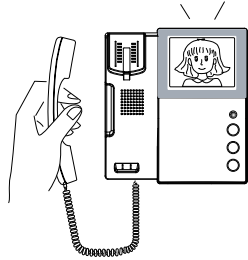

When the device has an extended monitor or door-phone, pick up the handset and press Extension  button.

Then, tone ring sounds from the monitor. At this time, the device shifts to communication mode automatically.

On the other hand, when an indoor call is received from the extended monitor or door-phone, pick up the handset. Then, communication is made available immediately.

In the state of picking up the handset, press Extension  button for communication.

Indoor communication is available for up to three minutes.

■ Name of Each Connection port

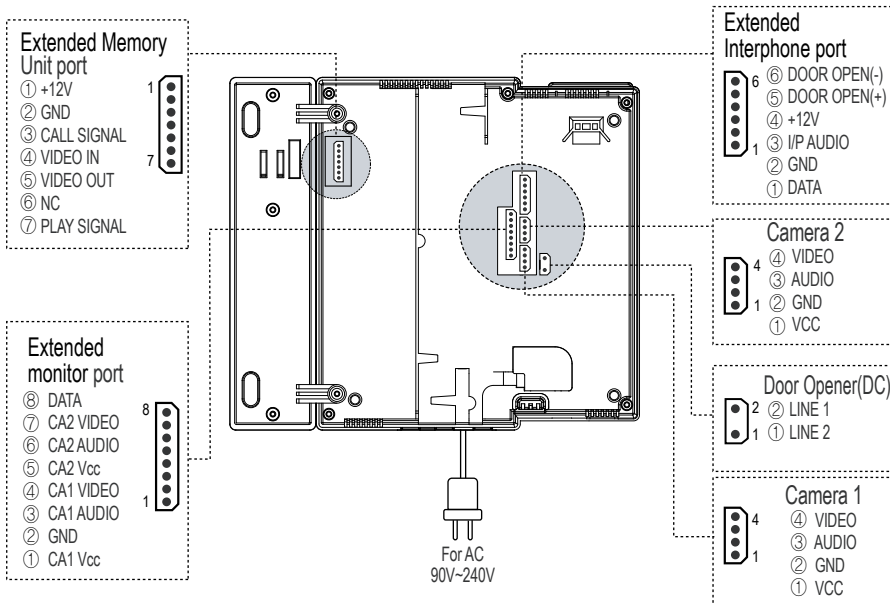

■ 1 Camera : 1 Monitor Connection

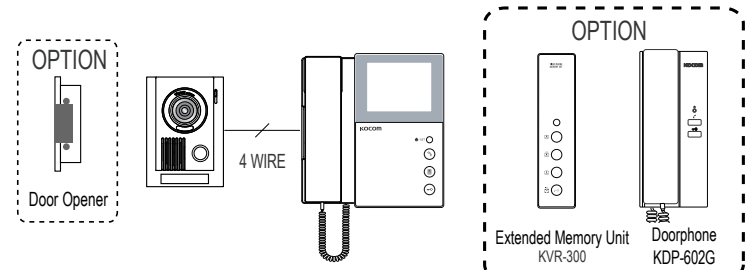

※ Play back the recorded image in black and white.

■ 2 Cameras : 1 Monitor Connection

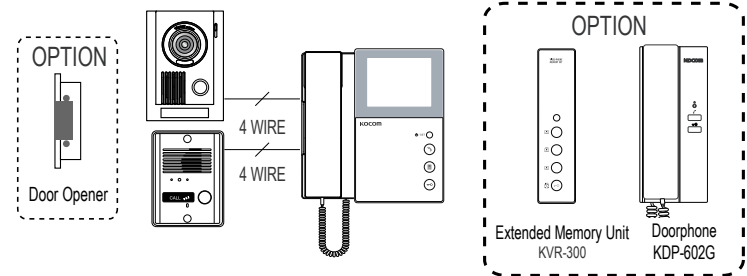

■ System configurations

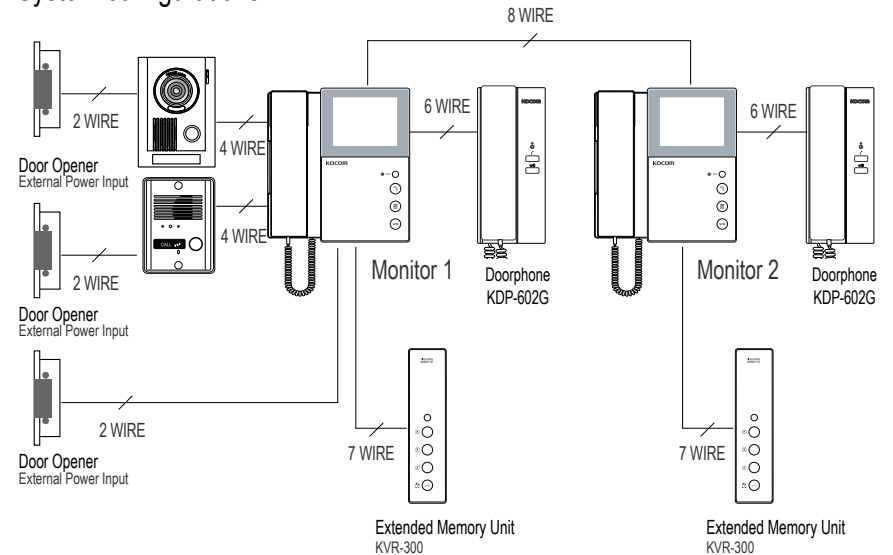

■ 1 Camera : 1 Monitor Connection Wiring

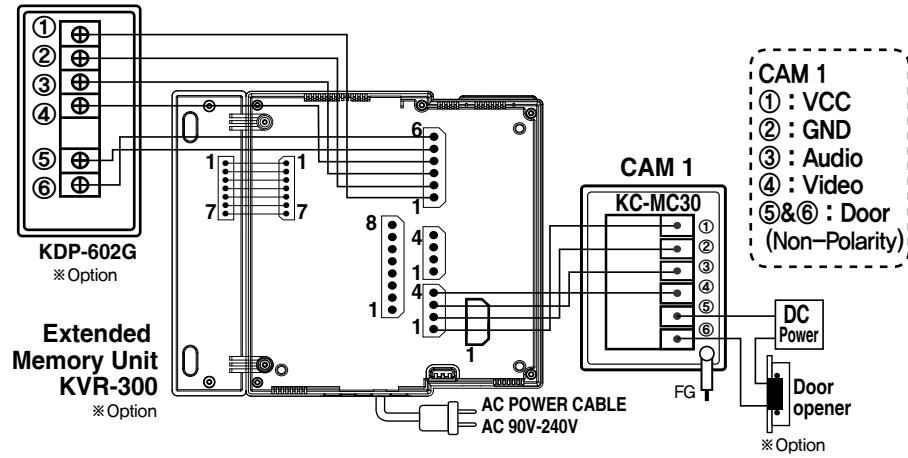

■ Full System Wiring / 2 Cameras : 2 Monitors Connection Wiring

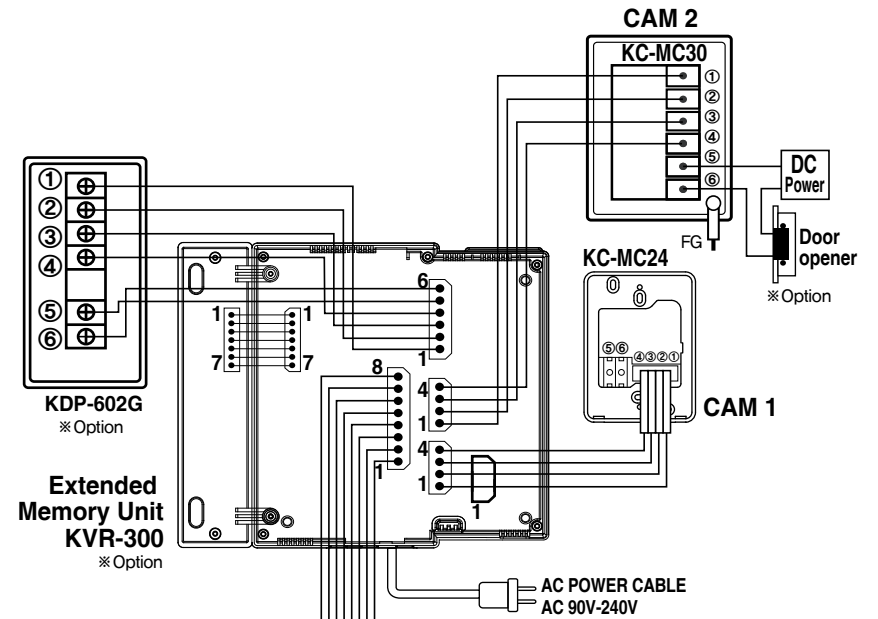

■ 2 Cameras : 1 Monitor Connection Wiring

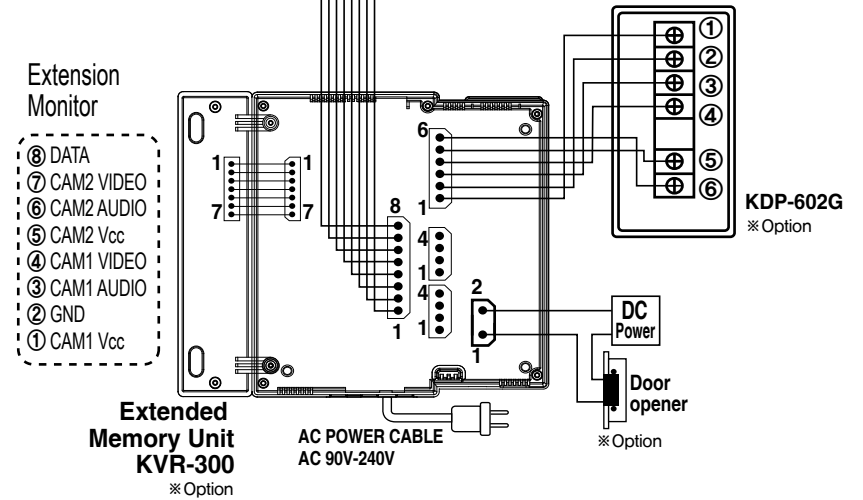
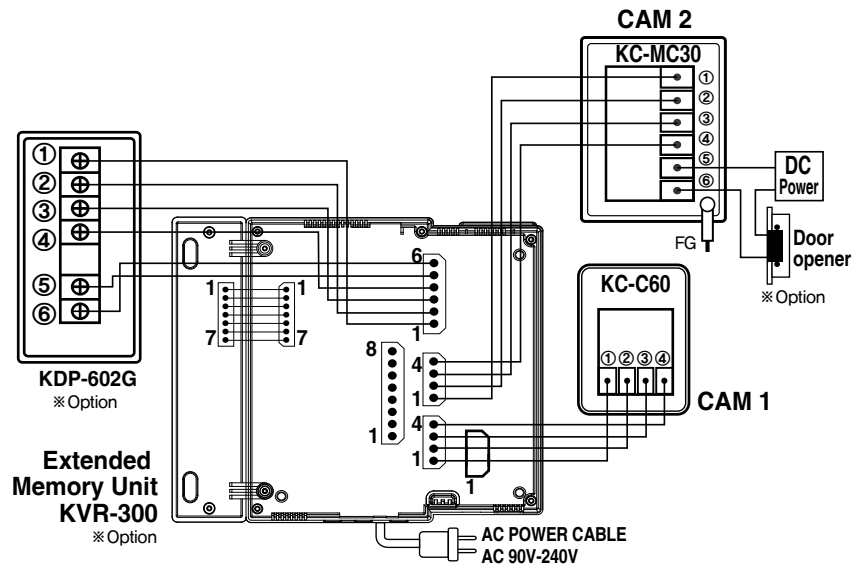

▶ **Wiring Diagram [Cable requirement]**

Based on distance from a camera to the monitor

■ Upto 100M : CAT5 cable

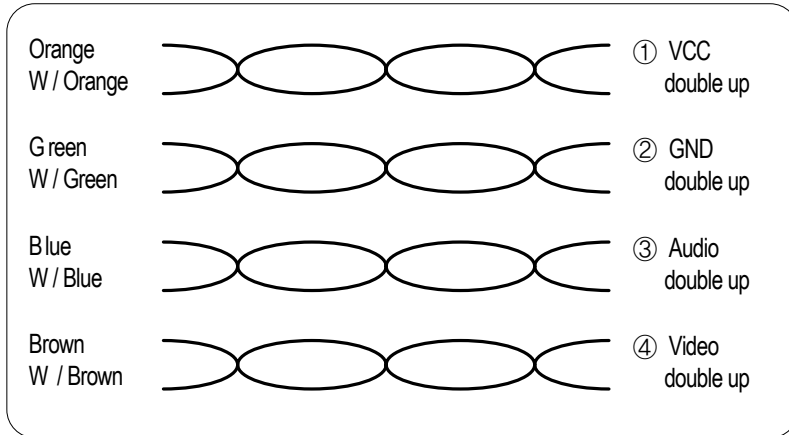

※ CAT5 wire configuration

※ In case of more than 50m of CAT5 cable length, the screen and voice quality can get lower. But the symptom is not a kind of fault. So less than 50m is recommended.

■ Upto 50M : TIV 0.65mm² cable

■ Upto 100M : Over TIV 0.8mm² cable

■ Upto 150M : TIV 0.8mm² cable + RG-59 / U

RG-59 / U (Coaxial cable) for Video signal
(Connect core to Video & shield to GND)

▶ **Wiring Diagram [CCTV Camera A type]**

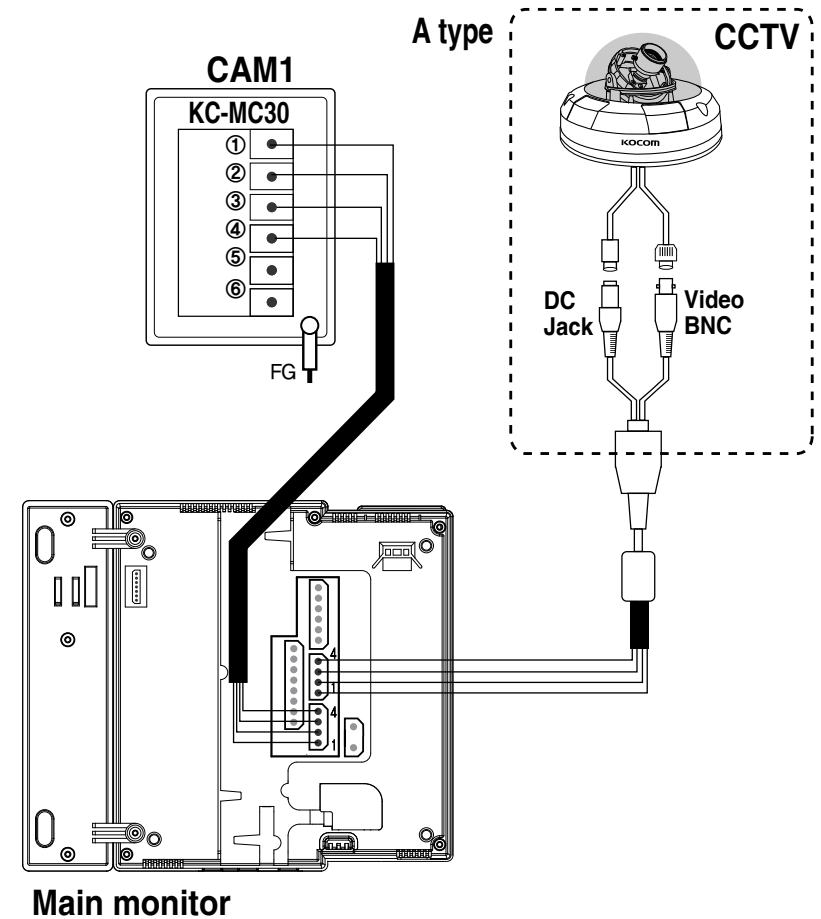

A. In case the power consumption of CCTV camera is below 200mA (DC12V) and in distance below 50M, you can use monitor power to CCTV camera.



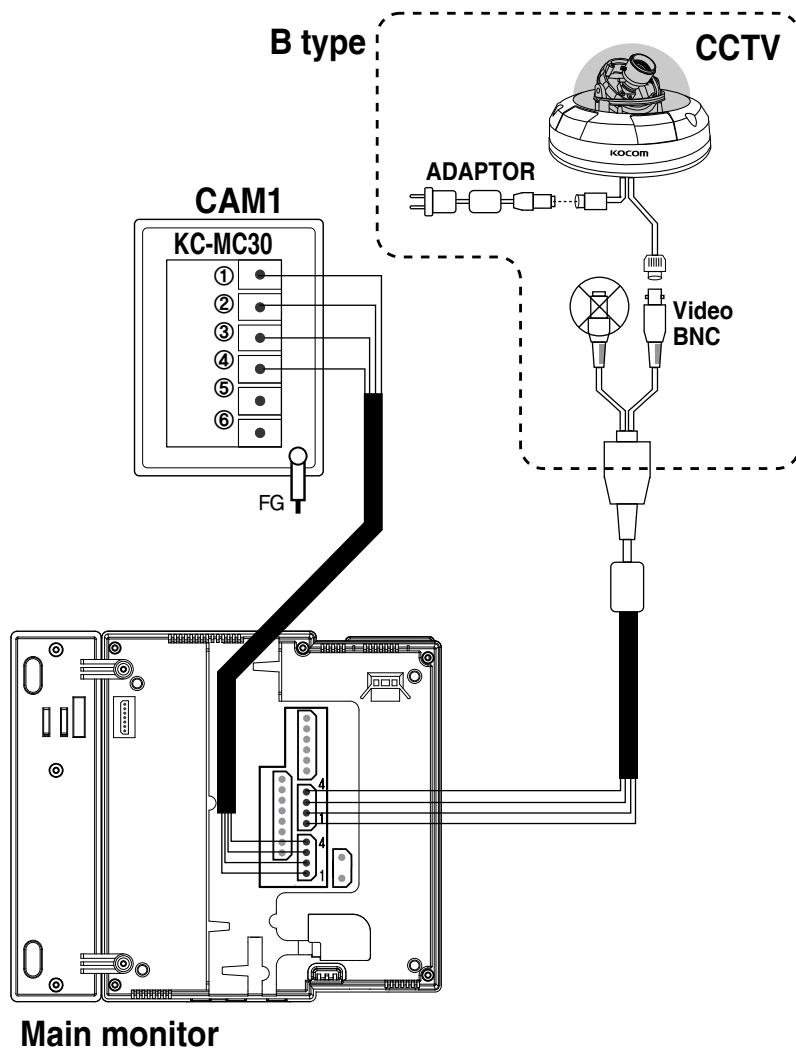

B. In case the power consumption of CCTV camera is over 200mA (DC 12V) and distance between CCTV camera and monitor is over 50M, the additional power supply should be used for CCTV camera.

▶ Wiring Diagram [CCTV Camera B type]







▶ Operational Descriptions of Special Functions



■ Door Camera Call Melody Selection (5 Melody)

With hanging up the handset, select the camera 1 or camera2 using monitoring function.
 While screen is on, press Extension  button for three seconds.
 Mode setting sound  rings.
 Every time you press Extension  button, saved bell sounds are output.
 Select the bell sound you want and press set  button to change the bell sound of related door camera.
 With mode setting sound  ringing, the changed bell sound is saved.
 Screen is automatically turned off.

■ Extension Call Melody Selection (5 Melody)

With hanging up the handset, press Extension  button
 Mode setting sound  rings.
 Every time you press Extension  button, saved bell sounds are output.
 Select the bell sound you want and press set  button to change the bell sound.
 With mode setting sound  ringing, the changed bell sound is saved.

■ CCTV Monitoring (3min)

With hanging up the handset, press camera  button to select the door camera for which you want to set CCTV monitoring function.
 While screen is on, press set  button for three seconds.
 With mode setting sound  ringing, monitoring time of the selected camera changes from one to three minutes.
 Screen is automatically turned off.
 To cancel this function, follow the same steps as described above.

External Memory Equipment (KVR-300) User's Manual

※Play back the recorded image in black and white.

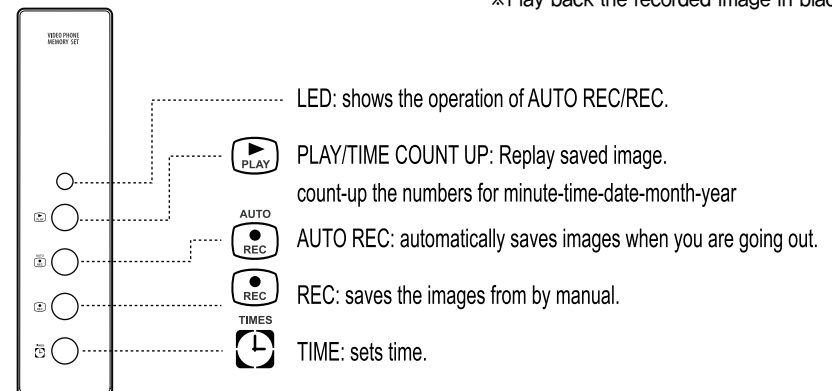

▶ Installation

KVR-300 contains the following WIRE.

You can connect this pin connector WIRE to WAFER of KVM-301 & KVM-D301. KCV-301

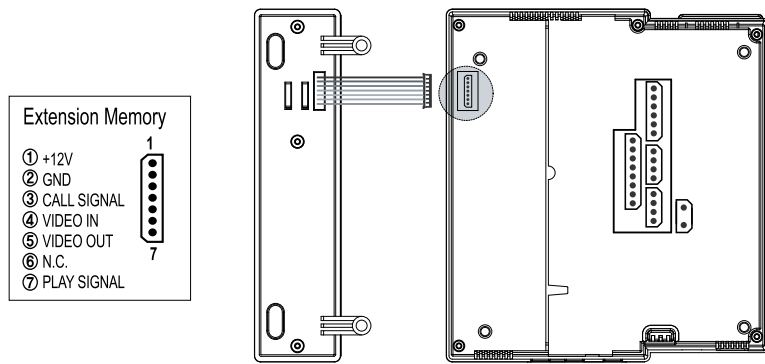

Installation

▶ How to operate ※Play back the recorded image in black and white.

■ Manual Record & Auto Record

1. Manual Record (REC): When the monitor screen is on, if you push "REC" button, the still image will be recorded.
2. Auto Record (AUTO REC): If you push "AUTO-REC" button, the green LED lamp will turn on and the still images will be recorded with blinking red color LED automatically, when the visitors push camera's call button. (The next auto recording images is available in 30 seconds interval)

■ Play Recorded Image

Upto 64 cut frame record

If you push "Play" button (PLAY), you can find the latest image with the time saved.

Push "play" button again to find the next image.

It's not available with auto re-play for all images by one push button.

※ In case the memory capacity is full, it automatically over writes from the oldest images in order.

■ Time Setting

1. Turn on the monitor's screen as pushing camera button.
2. Press "Time button" (TIMES) and (PLAY) button, then "Time Mode" appears at the center of monitor's screen and 'Minute' part blinks.
3. Change the number as pushing "Time set" button (TIMES) & select wanted number by "Time mode" button. As like above method, set time & date continuously (minutes > time > date > month > year).
4. (PLAY) button : Count-Up

※ Caution

- If the power to memory unit' is cut off, the time, date and all images are volatilized. Take care of this.
- When playing the recorded images, upper & lower part of the display can be blackened by terrestrial magnetism of each area.